

TORINO TABLE

ASSEMBLY GUIDE

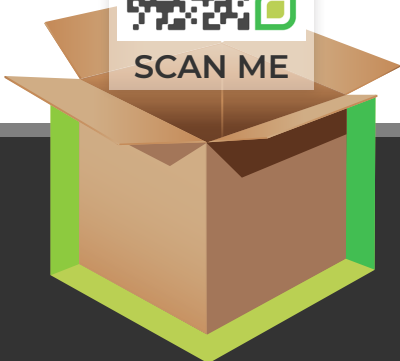
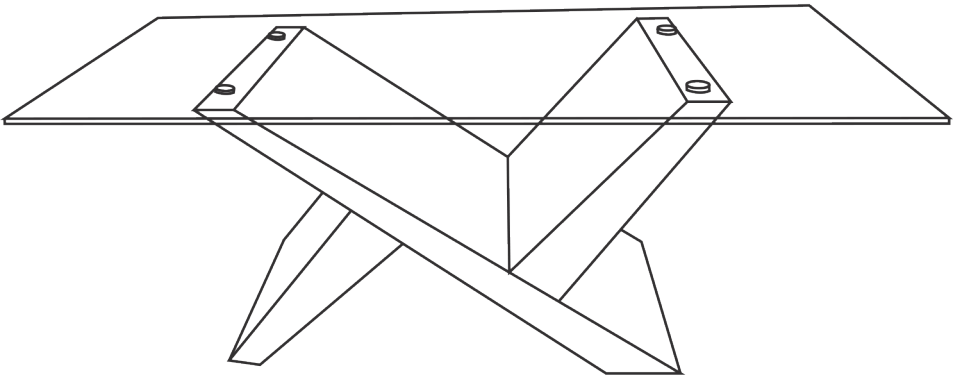

www.furniturebox.co.uk

Scan QR code for more tips,
advice and assembly video or visit
furniturebox.co.uk/club/torino

Important - Please read these instructions fully before starting assembly



**SAFETY AND
CARE ADVICE**



NO POWER TOOLS

SAFETY AND CARE ADVICE

- Check you have all the components and tools listed.
- Remove all fittings from the plastic bags and separate them into their groups.
- We do not recommend the use of power drills/drivers for inserting screws, as this could damage the unit. Only use hand screwdrivers and Allen keys.
- Keep children and animals away from the work area, small parts could cause choking if swallowed.
- Make sure you have enough space to layout the parts before starting.
- Assemble the item as close to its final position (in the same room) as possible.
- Do not overtighten the nuts to avoid causing damage to the threads.
- Only clean using a damp cloth and mild detergent, do not use bleach or abrasive cleaners.
- From time to time check that there are no loose screws on this unit
- This product should not be discarded with household waste. Take to your local authority waste disposal centre



Follow us on Instagram
@furniturebox_uk

IMPORTANT INFORMATION



45 MINUTE
BUILD











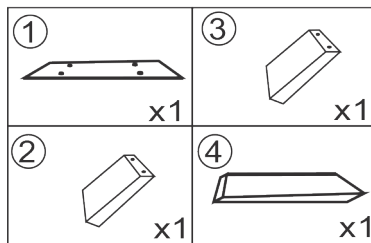



TWO
PERSON

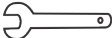

MAXIMUM
CAPACITY 100Kg

PLEASE CHECK CAREFULLY AND MAKE SURE YOU HAVE ALL FITTINGS AND TOOLS LISTED BELOW BEFORE YOU START.



A	 M8X40 Threaded Rod	x2	D	 M8X22mm Metal Washer	x8
B	 M8 Nut	x8	E	 Screw	x4
C	 Ø10x50	x4	F	 Cap	x2
G	 Box Spanner	x1	J	 Ø40PVC Stickers	x4
H	 Wrench	x1	K	 Ø60PVC Stickers	x4
I	 M8X100 Threaded Rod	x4	L	 M8X60	x2
			M	 M8X80	x2

NOTE: The quantities above are the correct amount to complete the assembly. In some cases more fittings may be supplied than are required.

STEP 1

Use a clear, flat, soft surface to avoid bumps or scratches.

First, connect leg [3] to large leg piece [4] - make sure you select the correct small leg piece to start with, here - they are in labelled boxes. Connect using wooden dowels [C] and threaded rod [I] followed by Washer [D] then Nut [B] and tighten with spanner [G]. Pop stickers [J] over the holes on the other side of leg piece [4], as per diagram.

Then, insert wooden dowels [C] and threaded rods [I] into the holes on leg piece [4] ready for the next leg to be attached.

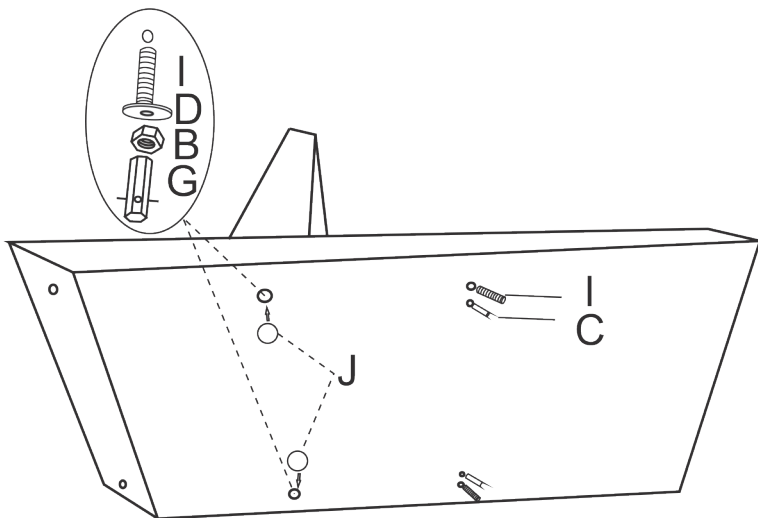

STEP 2

Attach leg piece [2] to leg piece [4]. Tighten and secure into place by inserting threaded bolt [I] into holes indicated on diagram, followed by washer [D], then part [F] and then nut [B]. Tighten with wrench [H].

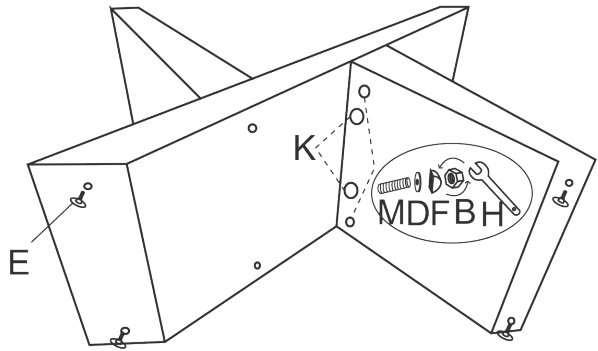

Attach the feet [E] to the bottom on leg pieces [4] and [2].

STEP 3

Carefully, and with help, flip your table correct side up, so it sits on its legs.

Next, carefully align the table top so that the metal discs align with the holes in the tops of leg pieces [4] and [3].

Fix table top to table by inserting threaded rod [A] into the holes in the leg pieces and screwing into the metal discs of the table top. Follow threaded rod [A] with washer [D] then nut [B] and tighten with spanner [G].

Ensure each metal disc of the table top is securely fixed to the leg pieces.

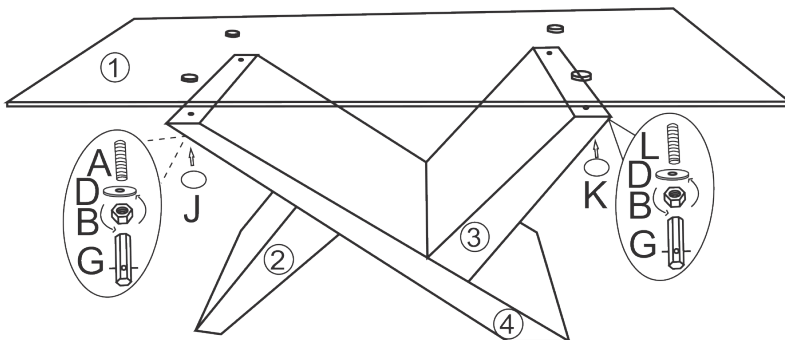



STEP 4

Check stability. Your table is now ready to use.

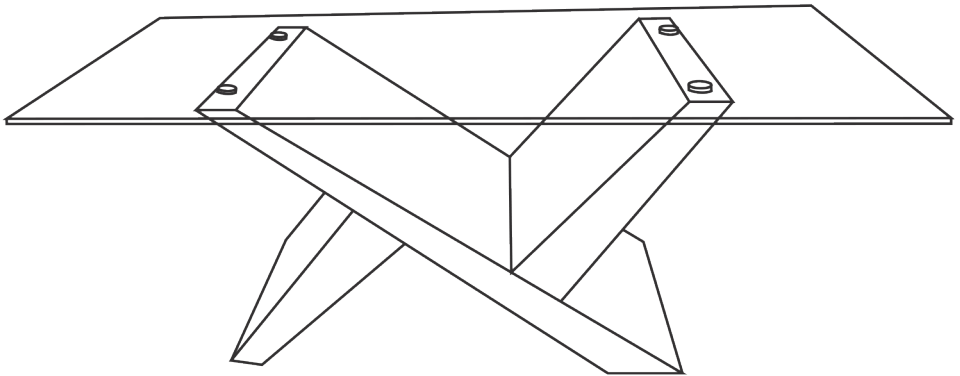

LOOKING GOOD!

Now you've assembled your product find out how to care for your item and keep it looking brand new.



Look for your care guide in the box or visit:
www.furniturebox.co.uk/club/care-guide



OUR 1 YEAR GUARANTEE

our products come with a 1 year guarantee to give you peace of mind shopping at Furniturebox



WHAT THE GUARANTEE COVERS



PRE-INSERTED FIXINGS

e.g. lose metal threads



FAULTY JOINTS

e.g. legs bending



EXTERNAL FIXING FAULTS

e.g. metal discs removing from table top



STRUCTURAL INTEGRITY

e.g. the frame of the product



ACTIVATE YOUR GUARANTEE ONLINE

scan this QR code with your phone to read the full guarantee online and register your product. It only takes a moment to fill out. Or visit: furniturebox.co.uk/our-guarantee

Furniturebox UK, Beaumont Business Centre,
Woodlands Road, Mere, Wiltshire, BA12 6BT
Tel: 01747 863333 Email: sales@furniturebox.co.uk