

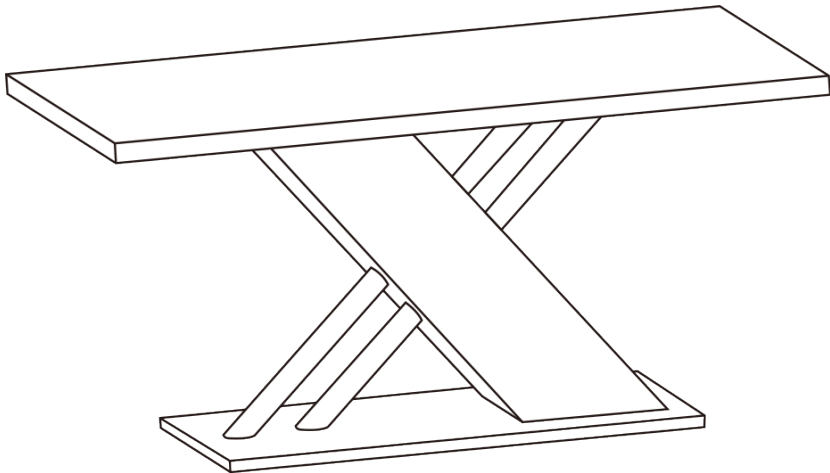

SORRENTO

DINING TABLE 4

ASSEMBLY GUIDE



www.furniturebox.co.uk

Scan QR code for more tips, advice
and assembly video or visit
furniturebox.co.uk/club/sorrento-4

Important - Please read these instructions fully before starting assembly



**SAFETY AND
CARE ADVICE**



NO POWER TOOLS

SAFETY AND CARE ADVICE

- Check you have all the components and tools listed.
- Remove all fittings from the plastic bags and separate them into their groups.
- We do not recommend the use of power drills/drivers for inserting screws, as this could damage the unit. Only use hand screwdrivers and Allen keys.
- Keep children and animals away from the work area, small parts could cause choking if swallowed.
- Make sure you have enough space to layout the parts before starting.
- Assemble the item as close to its final position (in the same room) as possible.
- Do not overtighten the nuts to avoid causing damage to the threads.
- Only clean using a damp cloth and mild detergent, do not use bleach or abrasive cleaners.
- From time to time check that there are no loose screws on this unit
- This product should not be discarded with household waste. Take to your local authority waste disposal centre



Follow us on Instagram
@furniturebox_uk

IMPORTANT INFORMATION



45 MINUTE
BUILD











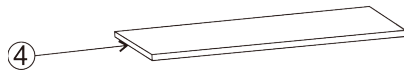
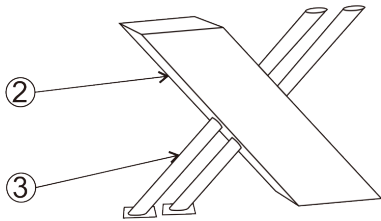
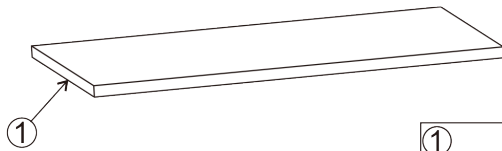







TWO
PERSON



MAXIMUM
CAPACITY 100Kg

PLEASE CHECK CAREFULLY AND MAKE SURE YOU HAVE ALL FITTINGS AND TOOLS LISTED BELOW BEFORE YOU START.



| | | | |
|---|---|--|---|
| ①  x1 | ②  x1 | ③  x2 | ④  x1 |
| A  M8*65mm x4 | B  M8*20mm x8 | C  M8*10mm x12 | D  M8*18mm x8 |
| E  M8*30mm x8 | F  M8*22mm x6 | G  x1 | H  x1 |
| I  Ø35 x4 | J  Ø30 x6 | K  Ø40 x4 | L  M8 x4 |

NOTE: The quantities above are the correct amount to complete the assembly. In some cases more fittings may be supplied than are required.



STEP 1

Put the pieces on a soft flat flat surface e.g. a carpet to avoid scratching or bumping. Insert part Ax4 Into the assembly holes of part 1 (the table top).

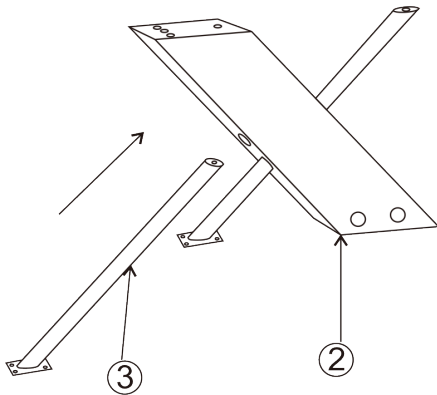
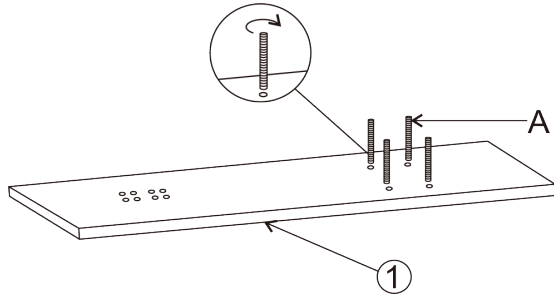

STEP 2

Insert the metal rods (part 3) into the table leg (part 2) as shown. Pay attention to the direction of the rods so that the base feet are facing downwards.



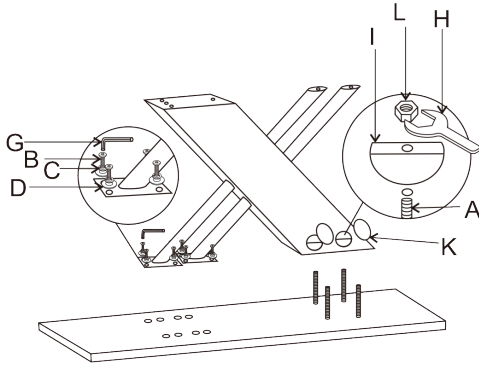

STEP 3

Add the table frame to the table top using the fixings indicated in the diagram.

ATTENTION: Do not fully tighten screws. Keep these screws slightly loose so the table angle can be adjusted and fixed once assembly is complete. Then use fixing K to cover the holes on the table legs (part 2) as shown.

STEP 4

Attach the table base (part 4) to the table legs using fixings G, E, C, F. Use fixing J to cover the holes on the table Base (part 4).

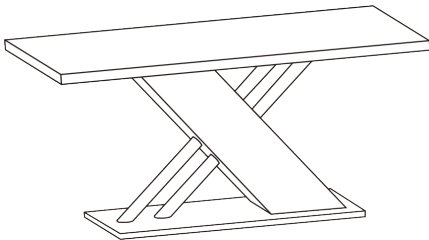
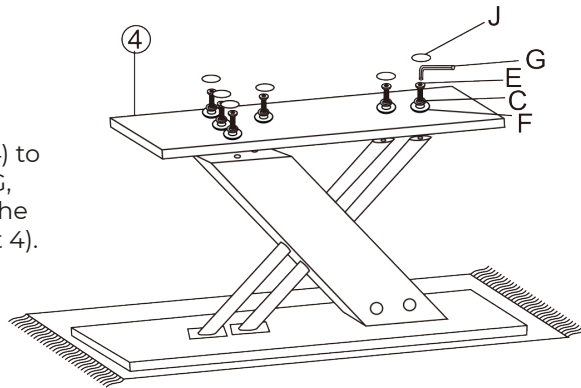

STEP 5

ATTENTION: Tighten all screws/bolts fully and then with help turn the table over. Assembly is now complete.

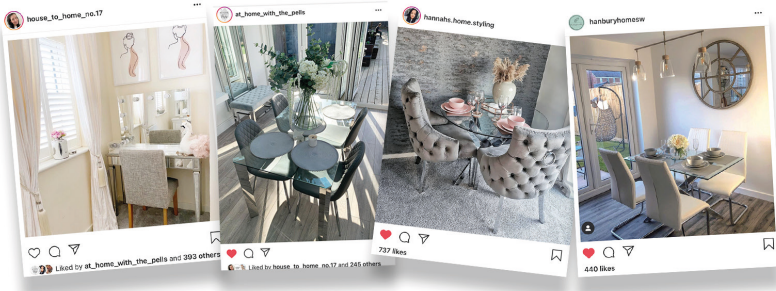

WE **L**♥**VE** INTERIORS! SHARE YOURS WITH US ON SOCIAL MEDIA

1. follow us on Instagram
2. post your interior
3. tag us to be featured



@furnitureboxUK



@furniturebox_uk



@furnitureboxuk

LOOKING GOOD!

Now you've assembled your product find out how to care for your item and keep it looking brand new.

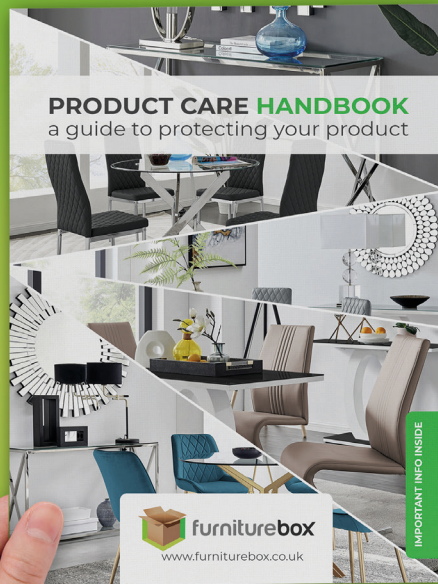

Look for your care guide in the box or visit:
www.furniturebox.co.uk/club/care-guide

www.furniturebox.co.uk



OUR 1 YEAR GUARANTEE

our products come with a 1 year guarantee to give you peace of mind shopping at Furniturebox



WHAT THE GUARANTEE COVERS



PRE-INSERTED FIXINGS

e.g. lose metal threads



FAULTY JOINTS

e.g. legs bending



EXTERNAL FIXING FAULTS

e.g. metal discs removing from table top



STRUCTURAL INTEGRITY

e.g. the frame of the product



ACTIVATE YOUR GUARANTEE ONLINE

scan this QR code with your phone to read the full guarantee online and register your product. It only takes a moment to fill out. Or visit: furniturebox.co.uk/our-guarantee

Furniturebox UK, Beaumont Business Centre,
Woodlands Road, Mere, Wiltshire, BA12 6BT
Tel: 01747 863333 Email: sales@furniturebox.co.uk