

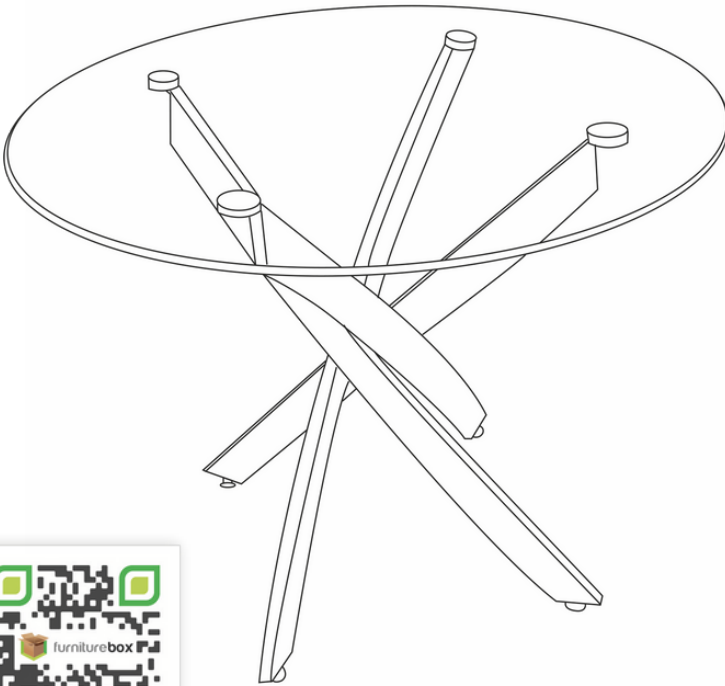

NOVARA - GLASS TOP

ASSEMBLY GUIDE



www.furniturebox.co.uk

Scan QR code for more tips, advice
and assembly video or visit
furniturebox.co.uk/club/novara

Important - Please read these instructions fully before starting assembly



SAFETY AND
CARE
ADVICE



NO POWER TOOLS

CAUTION



Under no circumstances should hot or cold items be placed directly onto the glass table surface. Table surface mats must be used at all times. Direct exposure to hot or cold items could seriously damage the product and compromise your warranty. For more information please refer to the product care guide booklet.



SAFETY AND CARE ADVICE

- Check you have all the components and tools listed.
 - Remove all fittings from the plastic bags and separate them into their groups.
 - We do not recommend the use of power drills/drivers for inserting screws, as this could damage the unit. Only use hand screwdrivers and Allen keys.
 - Keep children and animals away from the work area, small parts could cause choking if swallowed.
 - Make sure you have enough space to layout the parts before starting.
 - Assemble the item as close to its final position (in the same room) as possible.
 - Do not overtighten the nuts to avoid causing damage to the threads.
 - Only clean using a damp cloth and mild detergent, do not use bleach or abrasive cleaners.
 - From time to time check that there are no loose screws on this unit
- This product should not be discarded with household waste. Take to your local authority waste disposal centre



Follow us on
Instagram
@furniturebox_uk

IMPORTANT INFORMATION



45 MINUTE
BUILD



GLASS



MAXIMUM
CAPACITY 100Kg



TWO
PERSON

PLEASE CHECK CAREFULLY AND MAKE SURE YOU HAVE ALL FITTINGS AND TOOLS LISTED BELOW BEFORE YOU START.

1 x 1



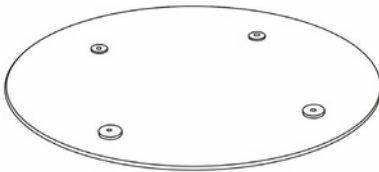





Table Top



2 x 4

Table Legs



<p>(A)  Rod 8x15mm x4</p>	<p>(B)  Nuts M8 x4</p>	<p>(C)  Table Feet x4</p>
<p>(D)  Washers Ø8x16mm x4</p>	<p>(E)  Screws 8x20mm x4</p>	<p>(F)  Wrench M8 x1</p>
<p>(G)  Allen key M5 x1</p>	<p>(H)  Connecting Piece x1</p>	

NOTE: The quantities above are the correct amount to complete the assembly. In some cases more fittings may be supplied than are required.

STEP 1

Use a clear, flat, soft surface to avoid bumps or scratches. Place the table top on the floor with the metal discs facing up. Screw 4 x rods [A] in to the metal discs.

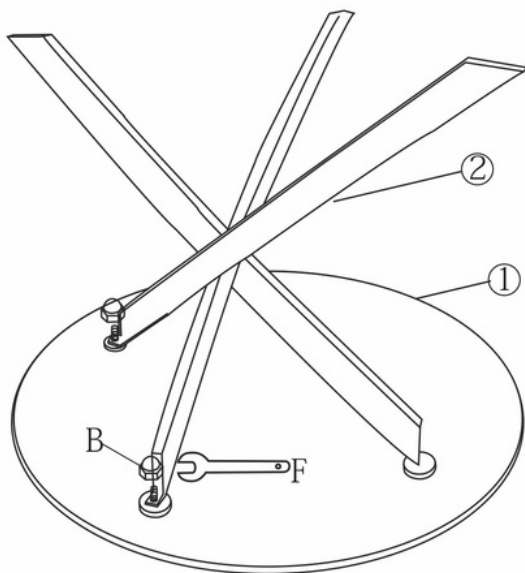
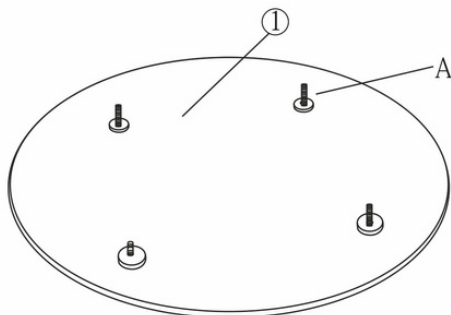

STEP 2

Place the table legs over the rods on to the metal discs. Use 4 x nuts [B] to secure table legs to table top. Repeat for all 4 table legs. **ATTENTION:** Be careful not to fully tighten fixings yet.



Follow us on
Instagram
@furniturebox_uk

STEP 3

Add feet [C] to bottoms of table legs.
 Connect all four legs together in the middle using the connecting piece [H], washers [D] screws [E]. Tighten with Allen key [G].
 Once connecting piece [H] is secured, you can then tighten all the table legs to the table top with wrench [F].

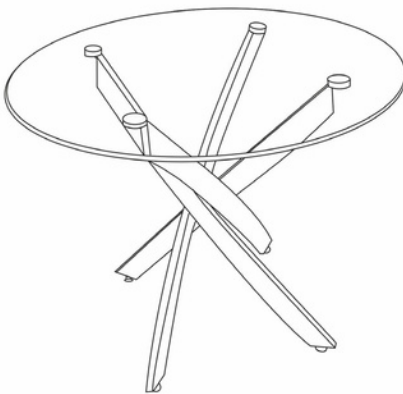
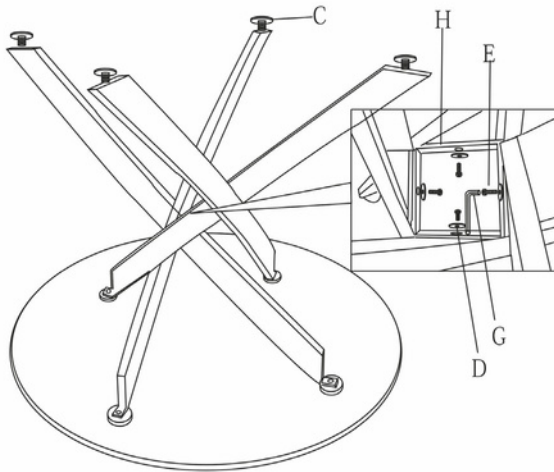

STEP 4

ATTENTION: Carefully, and with help, turn your completed table over so it's now the correct way up. Ensure stability.



WE **LOVE** INTERIORS! SHARE YOURS WITH US ON SOCIAL MEDIA

1. follow us on Instagram
2. post your interior
3. tag us to be featured



@furnitureboxUK



@furniturebox_uk



@furnitureboxuk

LOOKING GOOD!

Now you've assembled your product find out how to care for your item and keep it looking brand new.



Look for your care guide in the box or visit:
www.furniturebox.co.uk/club/care-guide

www.furniturebox.co.uk



OUR 2 YEAR* GUARANTEE

our products come with a 2 year guarantee to give you peace of mind shopping at Furniturebox

*excludes some garden furniture items which have a 1 year guarantee



WHAT THE GUARANTEE COVERS



PRE-INSERTED FIXINGS

e.g. lose metal threads



FAULTY JOINTS

e.g. legs bending



EXTERNAL FIXING FAULTS

e.g. bonding/glue



STRUCTURAL INTEGRITY

e.g. the frame of the product



ACTIVATE YOUR GUARANTEE ONLINE

scan this QR code with your phone to read the full guarantee online and register your product. It only takes a moment to fill out. Or visit: [furniturebox.co.uk/our-guarantee](https://www.furniturebox.co.uk/our-guarantee)



Furniturebox UK, Unit 6, St Modwen's Park,
Chippenham, SN15 5BD
Tel: 01747 863333 Email: sales@furniturebox.co.uk