

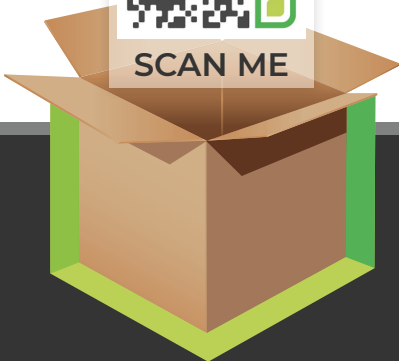

FOSSANO WARDROBE

ASSEMBLY GUIDE

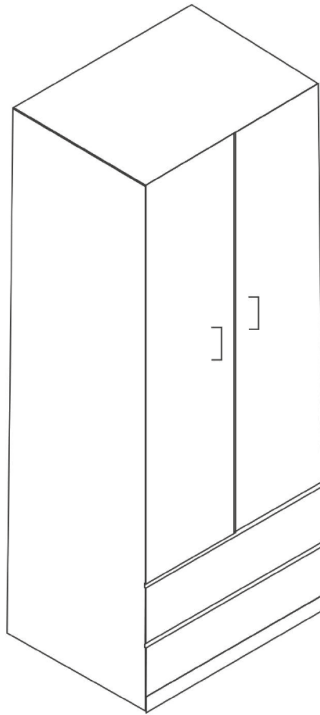

www.furniturebox.co.uk

Scan QR code for more tips,
advice and assembly video or visit
furniturebox.co.uk/club/fossano-wardrobe

IMPORTANT INFORMATION



60 MINUTE
BUILD



TWO
PERSON



MAXIMUM
CAPACITY 100Kg

Important - Please read these instructions fully before starting assembly



**SAFETY AND
CARE ADVICE**



NO POWER TOOLS

SAFETY AND CARE ADVICE

- Check you have all the components and tools listed.
- Remove all fittings from the plastic bags and separate them into their groups.
- We do not recommend the use of power drills/drivers for inserting screws, as this could damage the unit. Only use hand screwdrivers and Allen keys.
- Keep children and animals away from the work area, small parts could cause choking if swallowed.
- Make sure you have enough space to layout the parts before starting.
- Assemble the item as close to its final position (in the same room) as possible.
- Do not overtighten the nuts to avoid causing damage to the threads.
- Only clean using a damp cloth and mild detergent, do not use bleach or abrasive cleaners.
- From time to time check that there are no loose screws on this unit
- This product should not be discarded with household waste. Take to your local authority waste disposal centre











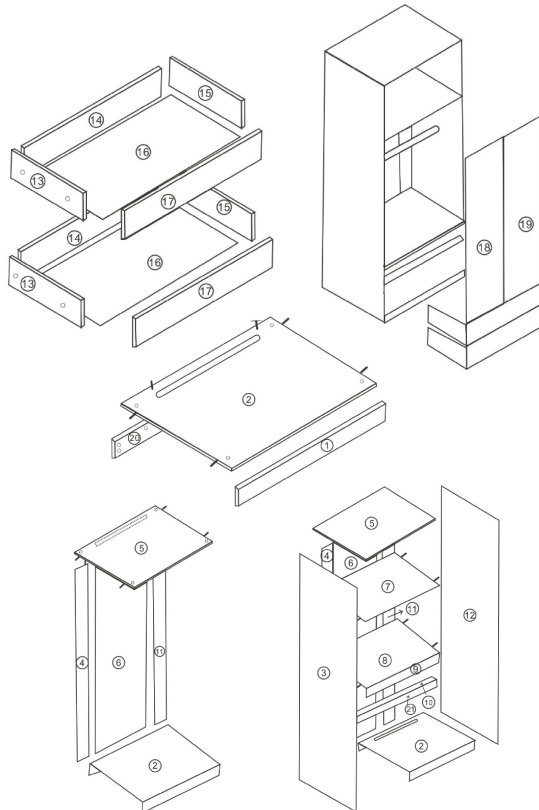



Follow us on Instagram
[@furniturebox_uk](https://www.instagram.com/furniturebox_uk)



PLEASE CHECK CAREFULLY AND MAKE SURE YOU HAVE ALL FITTINGS AND TOOLS LISTED BELOW BEFORE YOU START.

- ①- Front Footboard*1
- ②- Bottom Board*1
- ③- Left Wardrobe Side Board*1
- ④- Left Wardrobe Side Support*1
- ⑤- Top Board*1
- ⑥- Wardrobe Back*1
- ⑦- Upper Shelf*1
- ⑧- Lower Shelf*1
- ⑨- Upper Drawer Support*1
- ⑩- Fixing Plate*1
- ⑪- Right Wardrobe Side Support*1
- ⑫- Right Wardrobe Side Board*1
- ⑬- Drawer Side Piece*2
- ⑭- Drawer Front/Back Piece*2
- ⑮- Drawer Side Piece*2
- ⑯- Drawer Bottom Piece*2
- ⑰- Drawer Front/Back Piece*2
- ⑱- Left Wardrobe Door*1
- ⑲- Right Wardrobe Door*1
- ⑳- Back Footboard*1
- ㉑- Lower Drawer Support*1



 A Cam Lock Nut*74	 B Cam Screw*74	 C PVC Cover*74	 D Wooden Dowel*20	 E Self Tapping Slider*4	 F Metal Slider*2
 G Clothes Rail*1	 H Clothes Bar Bracket*2	 I Hinge*6	 J Door Handle*2	 K Handle Screw*4	 L Screwdriver*1

NOTE: The quantities above are the correct amount to complete the assembly. In some cases more fittings may be supplied than are required.



STEP 1

Put the pieces on a soft flat surface e.g. a carpet to avoid scratching or ready to bumping. Make the sure that you have all pieces and components ready to build the wardrobe.

Firstly use Screwdriver (L) to tighten the Cam Screws (B) into the bottom board (2). Once tightened the Cam Lock Nut (A) to lock in the pieces and assemble the front footboard (1) and back footboard (20) to the bottom board (2).

Assemble the lower shelf (8) and upper drawer support (9) together using cam screws and lock nuts.

Add the cam screws onto the fixing plate (10) and then fix the lower drawer support (21) to this part using the cam lock nuts.

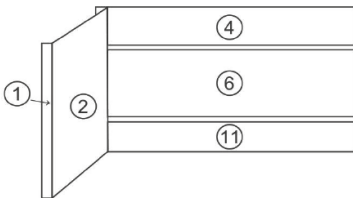
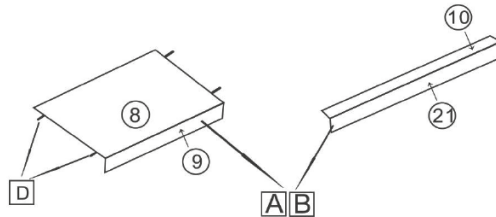
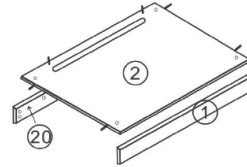

STEP 2

Connect the right wardrobe side support (11) and bottom board (2) with wooden dowels (D), cam lock nuts and cam screws.



STEP 3

Apply cam screws and wooden dowels onto the top board (5) to the left wardrobe side support (4), right wardrobe side support (11), wardrobe back (6). Tighten using cam lock nuts.

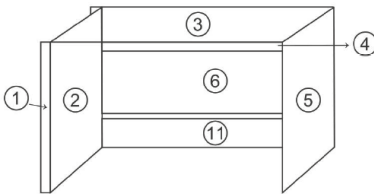
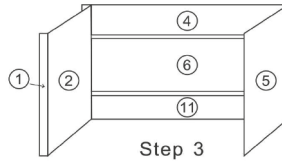

STEP 4

Assemble the left wardrobe side board (3), bottom board (2), left wardrobe side support (4) and top board (5) together.

STEP 5

ATTENTION: Using 2 people turn the cabinet 180 degrees, then assemble upper shelf (7), lower shelf (8), upper drawer (9), fixing plate (10) and lower drawer support (21) with left wardrobe side board (3)

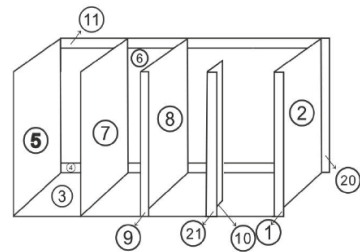

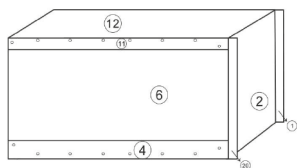

STEP 6

Assemble the right wardrobe side board (12).

STEP 7

Lift up the wardrobe with 2 people. Install the clothes bar bracket (H) and put the clothes rail (G) on. Please note the height of the clothes bar bracket is adjustable.

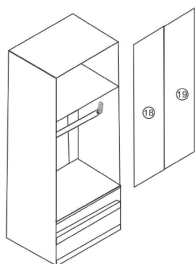
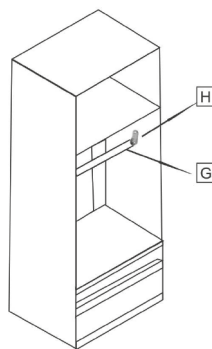

STEP 8

Assemble the left wardrobe door (18) and right wardrobe door (19). Then put the door handles (J) on.



STEP 9

Assemble the drawer (13), (14), (15), (16), (17) with the fixings (A), (B), and screwdriver (L).

Please note the front drawer (17) must be fixed last to allow the drawer bottom (16) to slide in before hand.

To assemble the runners correctly, press and hold the black plastic lever inside the slider (F) upward or downward, and pull outwards. This will separate the parent child parts of the slider (F), into two parts.

The child part (the runner with the black lever attached) needs to be assembled to the side of the drawer using the self tapping screw (E) to install the child parts at the corresponding holes of (13) and (15). Install the parent part at the corresponding holes of (3), (12) which is on the inside of the wardrobe side, with the black stopper on the parent runner at the furthest back point.

Pull the parent runner out and then push the drawer/child runner back onto the parent runner. Once aligned the drawer should fit straight in and function normally.

ATTENTION: Be careful not to overload drawers

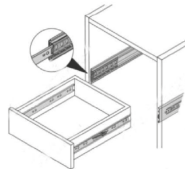
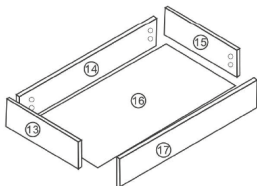
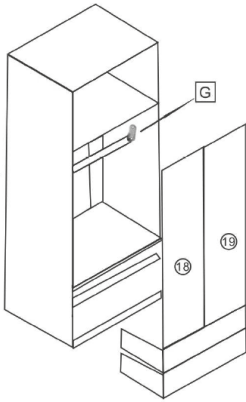

STEP 10

Using screwdriver (L) you can adjust the screw of the hinge to make sure the door seam is consistent

ATTENTION: The Anti Tipping Kit **MUST** be used to connect the cabinet to the wall to prevent tipping over.

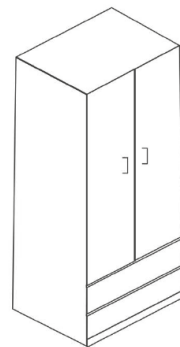

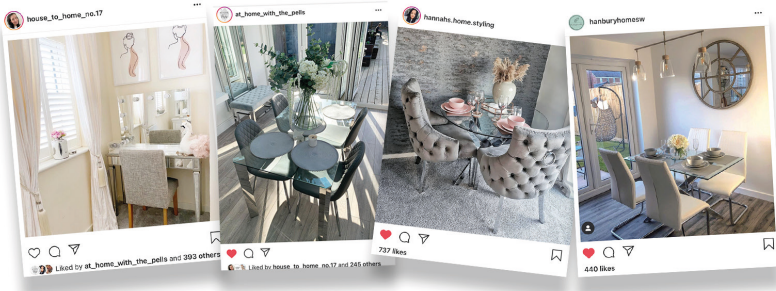

WE **L**♥**VE** INTERIORS! SHARE YOURS WITH US ON SOCIAL MEDIA

1. follow us on Instagram
2. post your interior
3. tag us to be featured



@furnitureboxUK



@furniturebox_uk



@furnitureboxuk

LOOKING GOOD!

Now you've assembled your product find out how to care for your item and keep it looking brand new.



Look for your care guide in the box or visit:
www.furniturebox.co.uk/club/care-guide

www.furniturebox.co.uk



OUR 1 YEAR GUARANTEE

our products come with a 1 year guarantee to give you peace of mind shopping at Furniturebox



WHAT THE GUARANTEE COVERS



PRE-INSERTED FIXINGS
e.g. lose metal threads



FAULTY JOINTS
e.g. legs bending



EXTERNAL FIXING FAULTS
e.g. metal discs removing from table top



STRUCTURAL INTEGRITY
e.g. the frame of the product



ACTIVATE YOUR GUARANTEE ONLINE

scan this QR code with your phone to read the full guarantee online and register your product. It only takes a moment to fill out. Or visit: furniturebox.co.uk/our-guarantee

Furniturebox UK, Beaumont Business Centre,
Woodlands Road, Mere, Wiltshire, BA12 6BT
Tel: 01747 863333 Email: sales@furniturebox.co.uk