

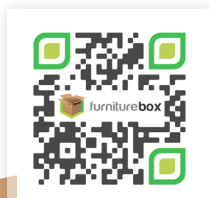

TAHITI CHAIR

ASSEMBLY GUIDE



SCAN ME

www.furniturebox.co.uk

Scan QR code for more tips,
advice and assembly video or visit
furniturebox.co.uk/club/tahitichair

Important - Please read these instructions fully before starting assembly



SAFETY AND CARE ADVICE



NO POWER TOOLS

SAFETY AND CARE ADVICE

- Check you have all the components and tools listed.
- Remove all fittings from the plastic bags and separate them into their groups.
- We do not recommend the use of power drills/drivers for inserting screws, as this could damage the unit. Only use hand screwdrivers and Allen keys.
- Keep children and animals away from the work area, small parts could cause choking if swallowed.
- Make sure you have enough space to layout the parts before starting.
- Assemble the item as close to its final position (in the same room) as possible.
- Do not overtighten the nuts to avoid causing damage to the threads.
- Only clean using a damp cloth and mild detergent, do not use bleach or abrasive cleaners.
- From time to time check that there are no loose screws on this unit
- This product should not be discarded with household waste. Take to your local authority waste disposal centre



Follow us on Instagram
@furniturebox_uk

IMPORTANT INFORMATION



30 MINUTE
BUILD













TWO
PERSON



MAXIMUM
CAPACITY
120Kg

PLEASE CHECK CAREFULLY AND MAKE SURE YOU HAVE ALL FITTINGS AND TOOLS LISTED BELOW BEFORE YOU START.

A 1pc	
B 1pc	
C 1pc	
aa 4pcs	 M6*15
bb 1pc	
G 1pc	
H 2pcs	
I 1pc	
aa 8pcs	 M6*15
bb 1pc	

NOTE: The quantities above are the correct amount to complete the assembly. In some cases more fittings may be supplied than are required.

STEP 1

Use a clear, flat, soft surface to avoid bumps or scratches. Lay all your components and fixings out. Note: we recommend you don't fully tighten any of the bolts until everything is fully assembled.

First, assemble the footrest.

Attach 2x leg pieces [H] to the footrest [G] using 4x washer + bolts [aa] on each leg - 8 in total. Fully tighten the bolts with Allen key [bb]. Flip footrest over to stand on its feet and check stability. Add cushion [I] and secure with ties.

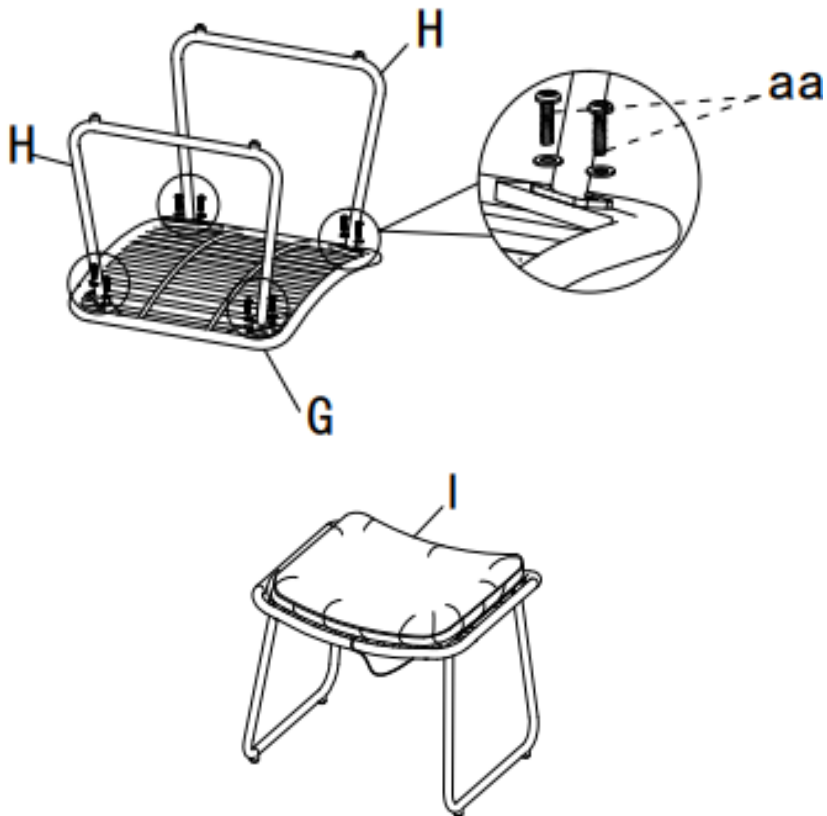

Follow us on Instagram
@furniturebox_uk

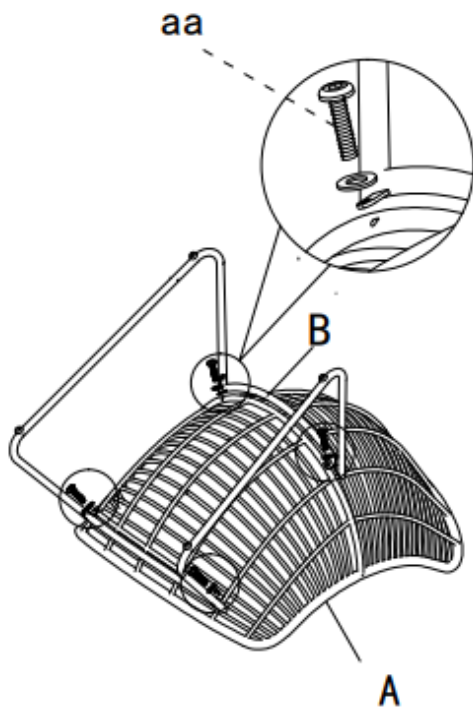

STEP 2

Next, assemble the chair. Attach the leg frame [B] to the chair seat [A] using 4x washers + bolts [aa]. Fully tighten with Allen key [bb]. Flip chair onto its feet and check stability. Add cushion [C].

Your chair and footrest are now ready to use!

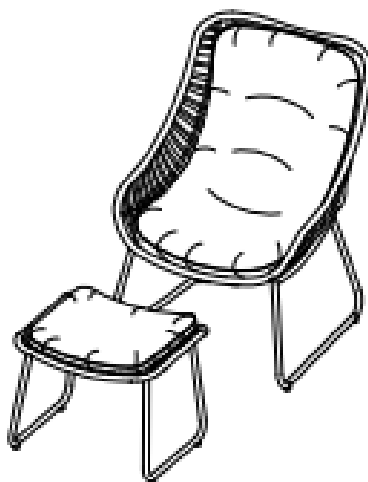
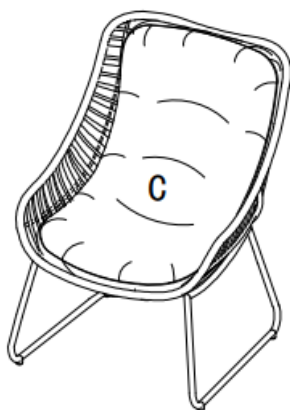



OUR 1 YEAR GUARANTEE

our products come with a 1 year guarantee to give you peace of mind shopping at Furniturebox



WHAT THE GUARANTEE COVERS



PRE-INSERTED FIXINGS
e.g. lose metal threads



FAULTY JOINTS
e.g. legs bending



EXTERNAL FIXING FAULTS
e.g. metal discs removing
from table top



STRUCTURAL INTEGRITY
e.g. the frame of the
product



ACTIVATE YOUR GUARANTEE ONLINE

scan this QR code with your phone to read the full guarantee online and register your product. It only takes a moment to fill out. Or visit: furniturebox.co.uk/our-guarantee

Furniturebox UK, Unit 6, St Modwen's Park,
Chippenham, SN15 5BD
Tel: 01747 863333 Email: sales@furniturebox.co.uk