

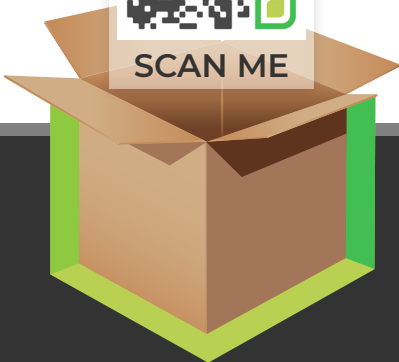

MOON CHAIR

ASSEMBLY GUIDE

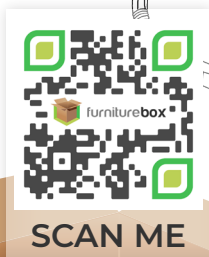
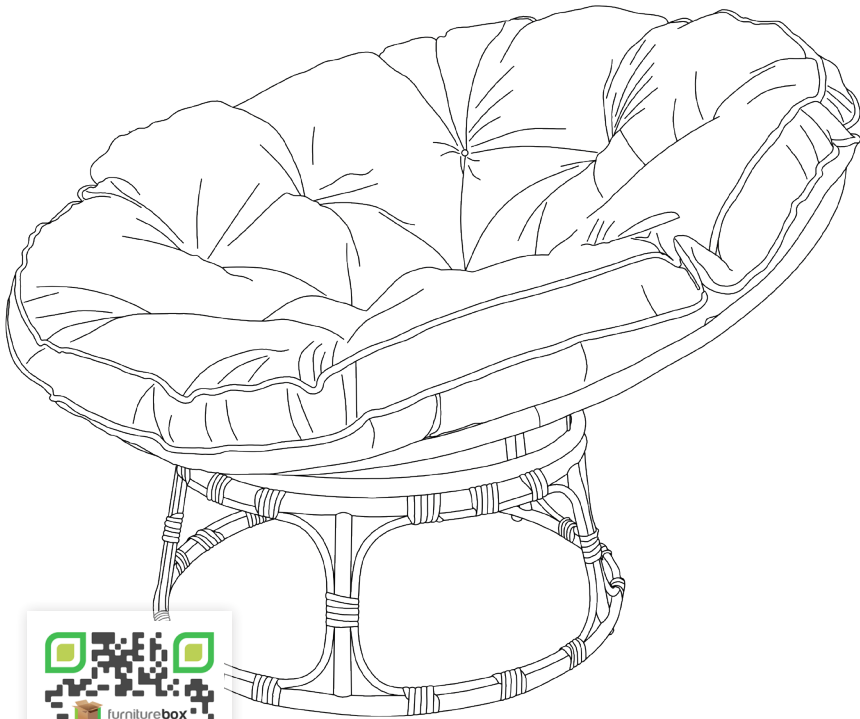

www.furniturebox.co.uk

Scan QR code for more tips, advice
and assembly video or visit
furniturebox.co.uk/club/moon-chair

Important - Please read these instructions fully before starting assembly



**SAFETY AND
CARE ADVICE**



NO POWER TOOLS

SAFETY AND CARE ADVICE

- Check you have all the components and tools listed.
- Remove all fittings from the plastic bags and separate them into their groups.
- We do not recommend the use of power drills/drivers for inserting screws, as this could damage the unit. Only use hand screwdrivers and Allen keys.
- Keep children and animals away from the work area, small parts could cause choking if swallowed.
- Make sure you have enough space to layout the parts before starting.
- Assemble the item as close to its final position (in the same room) as possible.
- Do not overtighten the nuts to avoid causing damage to the threads.
- Only clean using a damp cloth and mild detergent, do not use bleach or abrasive cleaners.
- From time to time check that there are no loose screws on this unit
- This product should not be discarded with household waste. Take to your local authority waste disposal centre



Follow us on Instagram
@furniturebox_uk

IMPORTANT INFORMATION



45 MINUTE
BUILD









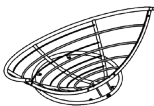

TWO
PERSON



MAXIMUM
CAPACITY 100Kg

PLEASE CHECK CAREFULLY AND MAKE SURE YOU HAVE ALL FITTINGS AND TOOLS LISTED BELOW BEFORE YOU START.

			 M6*20	 M6*38
A X1	B X1	C X1	D X4	E X4
 M6				
F X8	G X16	H X1	I X1	J X1

NOTE: The quantities above are the correct amount to complete the assembly. In some cases more fittings may be supplied than are required.



Construct your furniture on a nice flat, soft surface like a carpet, rug, or the lawn, to avoid any bumps and scratches. First, lay out all your pieces and check you have all the items listed on the inventory.

STEP 1

Connect the two halves of the seat [A] and [B]. Use bolt [E] + 1x washer [C] on one side of the holes and secure with 1x washer [C] + 1x nut [F] on the other side of the holes. Do this 4 times at the locations shown in the illustration. Thread bolts from seat section [A] down towards bottom section [B]. Don't fully tighten the bolts until all seat components are in place.

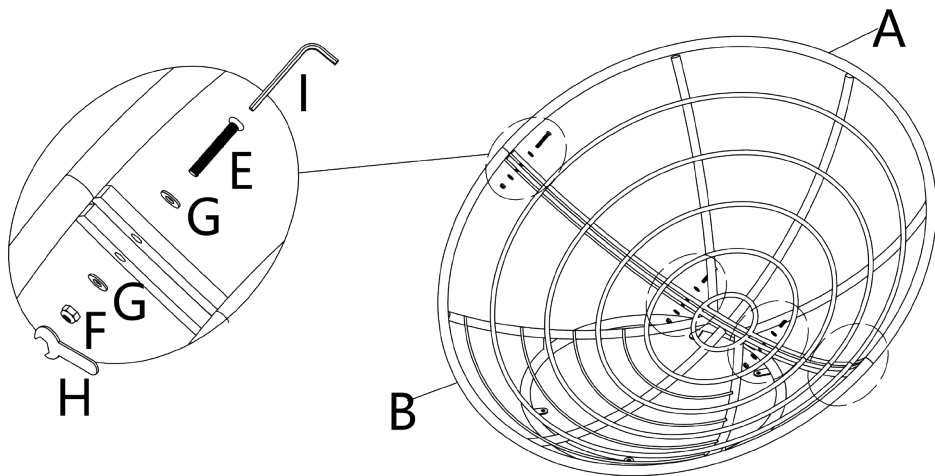

STEP 2

Carefully, and with help, place the seat on the base [C]. Ensure that the two black dots on the seat frame and the base line up before securing anything. Once aligned, connect seat to base using 1x bolt [D] + 1x washer [G] down from top to bottom, and secure with 1x washer [G] + 1x nut [F] on the other side of the hole. Repeat this 4 times at the locations shown in the illustration.

Once everything is in place, go ahead and tighten all the bolts, but take care not to over-tighten.

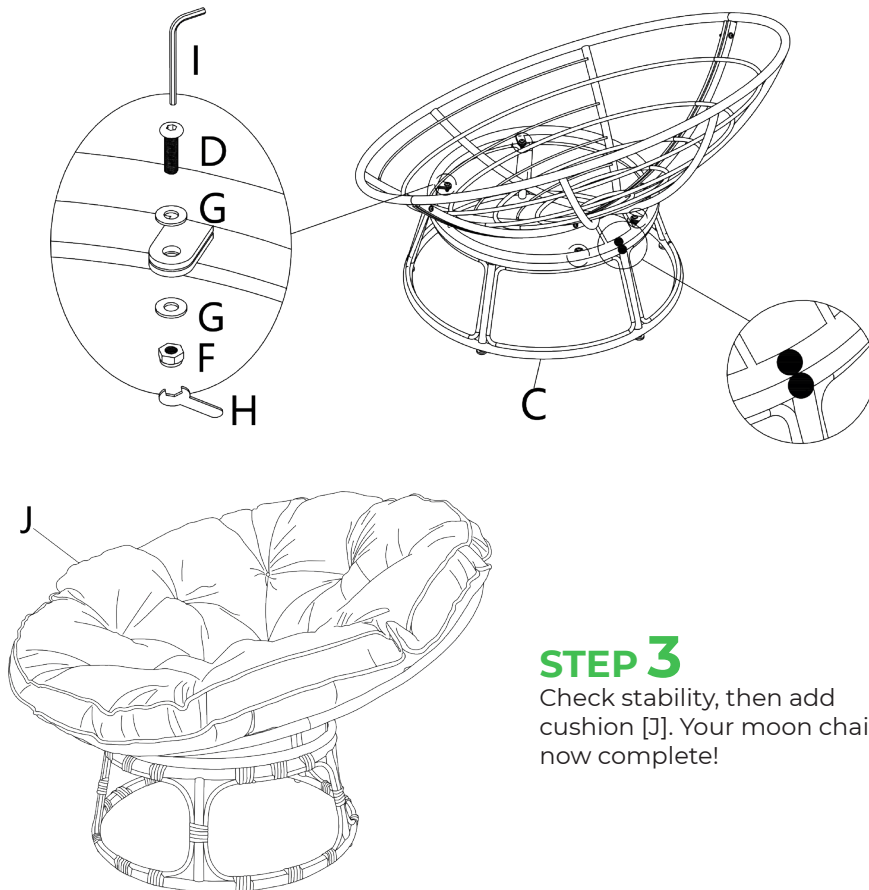

STEP 3

Check stability, then add cushion [J]. Your moon chair is now complete!

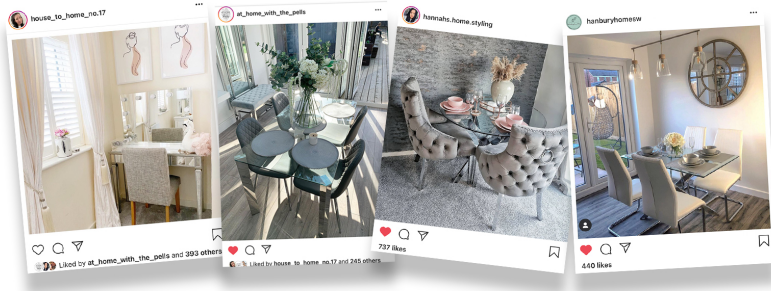

WE **LOVE** INTERIORS! SHARE YOURS WITH US ON SOCIAL MEDIA

1. follow us on Instagram
2. post your interior
3. tag us to be featured



@furnitureboxUK



@furniturebox_uk



@furnitureboxuk

LOOKING GOOD!

Now you've assembled your garden furniture find out how to care for your item and keep it looking brand new.



Look for your care guide in the box or visit:
www.furniturebox.co.uk/club/care-guide

www.furniturebox.co.uk



OUR 1 YEAR GUARANTEE

our products come with a 1 year guarantee to give you peace of mind shopping at Furniturebox



WHAT THE GUARANTEE COVERS



PRE-INSERTED FIXINGS
e.g. lose metal threads



FAULTY JOINTS
e.g. legs bending



EXTERNAL FIXING FAULTS
e.g. metal discs removing from table top



STRUCTURAL INTEGRITY
e.g. the frame of the product



ACTIVATE YOUR GUARANTEE ONLINE

scan this QR code with your phone to read the full guarantee online and register your product. It only takes a moment to fill out. Or visit: furniturebox.co.uk/our-guarantee

Furniturebox UK, Beaumont Business Centre,
Woodlands Road, Mere, Wiltshire, BA12 6BT
Tel: 01747 863333 Email: sales@furniturebox.co.uk