

# MAYFAIR COFFEE TABLE

## ASSEMBLY GUIDE

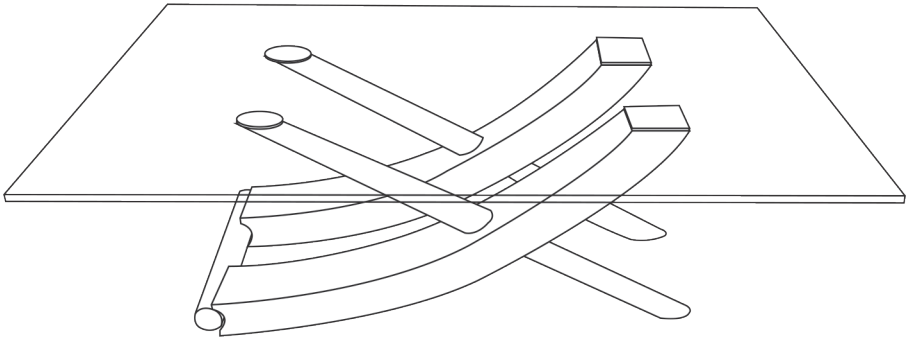

[www.furniturebox.co.uk](http://www.furniturebox.co.uk)

Scan QR code for more tips, advice and  
assembly video or visit  
[furniturebox.co.uk/club/mayfair-coffee](http://furniturebox.co.uk/club/mayfair-coffee)



**Important - Please read these instructions fully before starting assembly**



**SAFETY AND  
CARE ADVICE**



**NO POWER TOOLS**

## **SAFETY AND CARE ADVICE**

- Check you have all the components and tools listed.
- Remove all fittings from the plastic bags and separate them into their groups.
- We do not recommend the use of power drills/drivers for inserting screws, as this could damage the unit. Only use hand screwdrivers and Allen keys.
- Keep children and animals away from the work area, small parts could cause choking if swallowed.
- Make sure you have enough space to layout the parts before starting.
- Assemble the item as close to its final position (in the same room) as possible.
- Do not overtighten the nuts to avoid causing damage to the threads.
- Only clean using a damp cloth and mild detergent, do not use bleach or abrasive cleaners.
- From time to time check that there are no loose screws on this unit
- This product should not be discarded with household waste. Take to your local authority waste disposal centre



# IMPORTANT INFORMATION



45 MINUTE  
BUILD



TWO  
PERSON

















GLASS

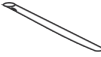

MAXIMUM  
CAPACITY 100Kg

PLEASE CHECK CAREFULLY AND MAKE SURE YOU HAVE ALL FITTINGS AND TOOLS LISTED BELOW BEFORE YOU START.

<p>① </p> <p>X1</p>	<p>A  2</p>	<p>G  1</p>
	<p>B  6 8X10mm</p>	<p>H  1</p>
<p>② </p> <p>X2</p>	<p>C  10 Ø8X18mm</p>	<p>I  1</p>
	<p>D  2 8X30mm</p>	<p>J  2 Ø50mm</p>
<p>③ </p> <p>X2</p>	<p>E  2 Ø8X90mm</p>	<p>K  2</p>
	<p>④ </p> <p>X1</p>	<p>F  2 Ø8mm</p>

**NOTE:** The quantities above are the correct amount to complete the assembly. In some cases more fittings may be supplied than are required.



## STEP 1

Use a clear, flat, soft surface to avoid bumps or scratches.

Slot chrome leg [3] through hole in high-gloss leg [2].

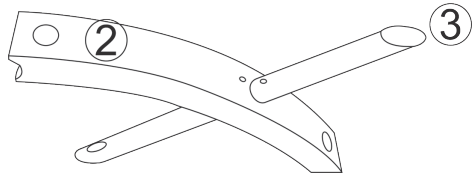

## STEP 2

Secure the two legs together using 1 x bracket [A] and washer [C] then screw [B] per hole in bracket. Tighten with Allen key [G].

Place tabletop [1] face down on flat, soft surface

Secure high-gloss leg to rectangular plate on table top using 1 x washer [C] followed by 1 x screw [D].

Secure chrome leg to circular plate on table top using 1 x washer [C] followed by 1 x screw [D].

Tighten all screws with Allen key [G]

Then repeat this process to attach 2nd set of legs.

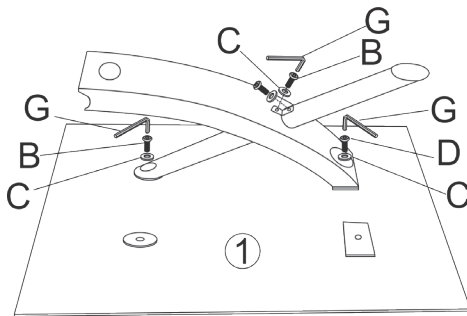

### STEP 3

Attach non-slip footpads [K] to the bottom of the chrome legs.

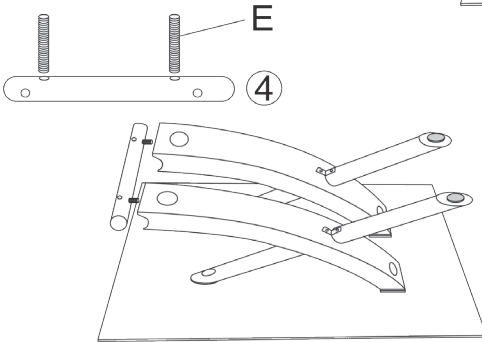
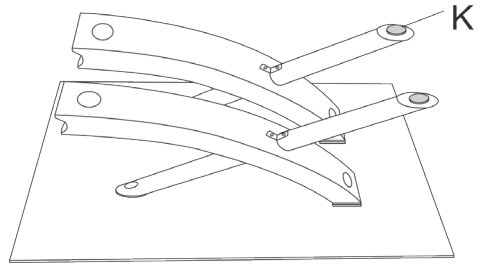

### STEP 4

Attach chrome table foot bar [4] to the high-gloss legs using 2 x rod bolts [E].

### STEP 5

Secure the chrome foot bar [4] to the legs using 1 x washer [C] followed by nut [F] per rod bolt, and tighten with spanner [H].

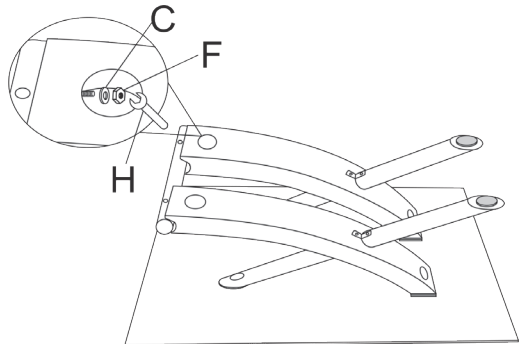



## STEP 6

Screw in feet [I] to chrome foot bar. Cover bolt holes with stickers [J].

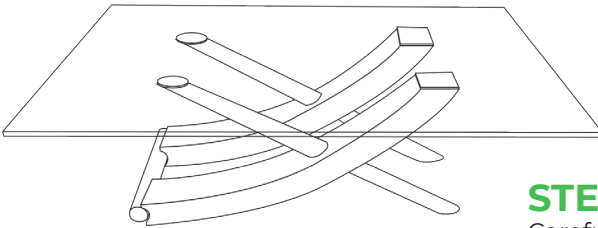
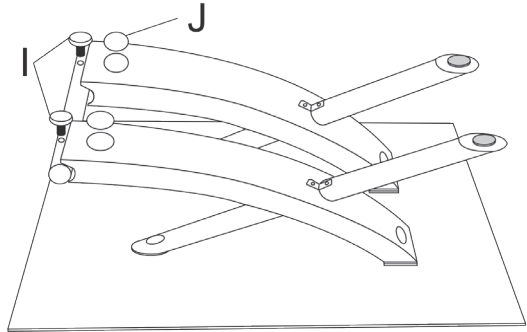

## STEP 7

Carefully, and with help, flip your table correct side up, so it sits on its legs. Check stability. Your coffee table is now ready to use.

# LOOKING GOOD!

Now you've assembled your product find out how to care for your item and keep it looking brand new.



Look for your care guide in the box or visit:  
[www.furniturebox.co.uk/club/care-guide](http://www.furniturebox.co.uk/club/care-guide)



## OUR 1 YEAR GUARANTEE

our products come with a 1 year guarantee to give you peace of mind shopping at Furniturebox



## WHAT THE GUARANTEE COVERS



### PRE-INSERTED FIXINGS

e.g. lose metal threads



### FAULTY JOINTS

e.g. legs bending



### EXTERNAL FIXING FAULTS

e.g. metal discs removing from table top



### STRUCTURAL INTEGRITY

e.g. the frame of the product



## ACTIVATE YOUR GUARANTEE ONLINE

scan this QR code with your phone to read the full guarantee online and register your product. It only takes a moment to fill out. Or visit: [furniturebox.co.uk/our-guarantee](https://furniturebox.co.uk/our-guarantee)

Furniturebox UK, Beaumont Business Centre,  
Woodlands Road, Mere, Wiltshire, BA12 6BT  
Tel: 01747 863333 Email: [sales@furniturebox.co.uk](mailto:sales@furniturebox.co.uk)