

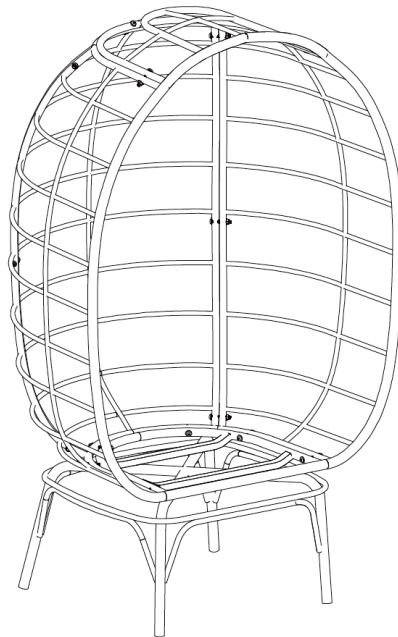

# EGG CHAIR

## ASSEMBLY GUIDE



[www.furniturebox.co.uk](http://www.furniturebox.co.uk)

Scan QR code for more tips, advice  
and assembly video or visit  
[furniturebox.co.uk/club/egg-chair](http://furniturebox.co.uk/club/egg-chair)

**Important - Please read these instructions fully before starting assembly**



**SAFETY AND  
CARE ADVICE**



**NO POWER TOOLS**

### **SAFETY AND CARE ADVICE**

- Check you have all the components and tools listed.
- Remove all fittings from the plastic bags and separate them into their groups.
- We do not recommend the use of power drills/drivers for inserting screws, as this could damage the unit. Only use hand screwdrivers and Allen keys.
- Keep children and animals away from the work area, small parts could cause choking if swallowed.
- Make sure you have enough space to layout the parts before starting.
- Assemble the item as close to its final position (in the same room) as possible.
- Do not overtighten the nuts to avoid causing damage to the threads.
- Only clean using a damp cloth and mild detergent, do not use bleach or abrasive cleaners.
- From time to time check that there are no loose screws on this unit
- This product should not be discarded with household waste. Take to your local authority waste disposal centre



**Follow us on Instagram**  
**@furniturebox\_uk**

## IMPORTANT INFORMATION



45 MINUTE  
BUILD















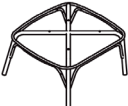

TWO  
PERSON

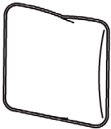

MAXIMUM  
CAPACITY 100Kg

PLEASE CHECK CAREFULLY AND MAKE SURE YOU HAVE ALL FITTINGS AND TOOLS LISTED BELOW BEFORE YOU START.

<p><b>A</b></p>  <p>1PC</p>	<p><b>B</b></p>  <p>1PC</p>	<p><b>C</b></p>  <p>1PC</p>	<p><b>D</b></p>  <p>1PC</p>
<p><b>E</b></p>  <p>1PC</p>	<p><b>F</b></p>  <p>1PC</p>	<p><b>G</b></p>  <p>M6*35mm 4PCS</p>	<p><b>H</b></p>  <p>M6*50mm 6PCS</p>
<p><b>I</b></p>  <p>M6*55mm 9PCS</p>	<p><b>J</b></p>  <p>34PCS</p>	<p><b>K</b></p>  <p>9PCS</p>	<p><b>L</b></p>  <p>6PCS</p>
<p><b>M</b></p>  <p>1PC</p>	<p><b>N</b></p>  <p>1PC</p>	<p><b>O</b></p>  <p>1PC</p>	<p><b>P</b></p>  <p>2PCS</p>
<p><b>Q</b></p>  <p>1PC</p>			

**NOTE:** The quantities above are the correct amount to complete the assembly. In some cases more fittings may be supplied than are required.

Construct your furniture on a nice flat, soft surface like a carpet, rug, or the lawn, to avoid any bumps and scratches. First, lay out all your pieces and check you have all the items listed on the inventory.

## STEP 1

Don't fully tighten any of the bolts until all of the components are in place.

Connect the side pieces [A] and [B] to the centre piece [C] using 6x bolts [H] and 12x washers [J] with 6x nuts [K]. Double check you're using the correct bolts here. Thread the bolts from the centre panel facing outwards, and secure with the washer and nuts from the side-panel side of the holes, as illustrated in the zoomed-in segment.

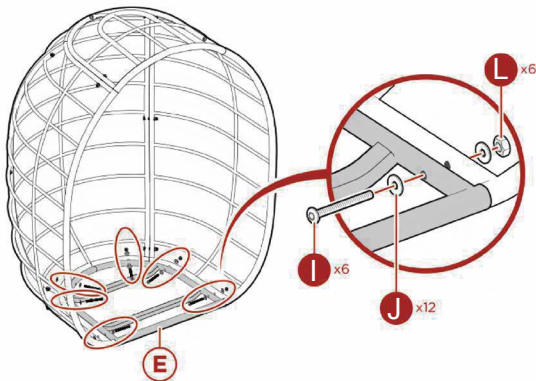
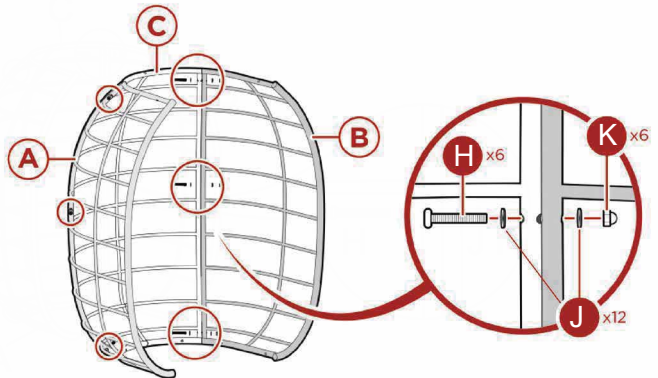

## STEP 2

Connect the bottom piece [E] using 6x bolts [I] and 6x washers [J] with 6x nuts [L] and 6x washers [J]. Thread the bolts through the bottom piece, facing outwards, and secure with washers and nuts on the other side of the holes, as illustrated in the zoomed-in segment.



Follow us on Instagram  
@furniturebox\_uk

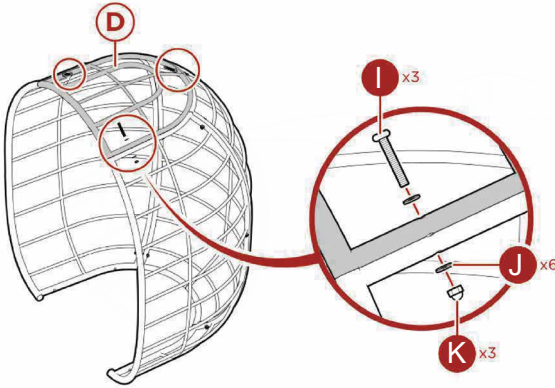

### STEP 3

Attach the top piece [D] using 3x bolts [I] and 3x washers [J] with 3x nuts [K]. Check you're using the correct bolts here. Thread the bolts through from the top piece facing in towards the side/back pieces, and secure with washers and nuts on the other side of the holes, as illustrated in the zoomed-in segment.

### STEP 4

Carefully lay your seat face-down on the flat surface to attach the legs piece [F]. Use 4x bolts [G] and washers [J]. Thread bolts through from outside of piece [F] towards the inside of the seat.

Once everything is in place, go ahead and tighten all of the bolts, but take care not to over-tighten.

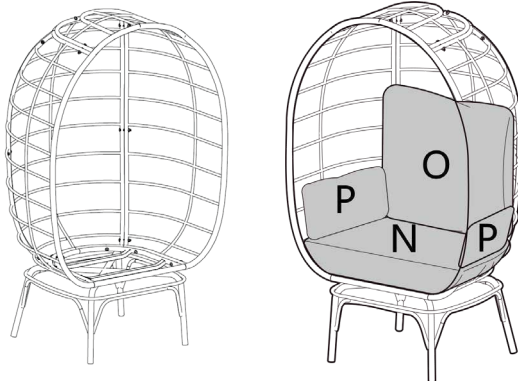
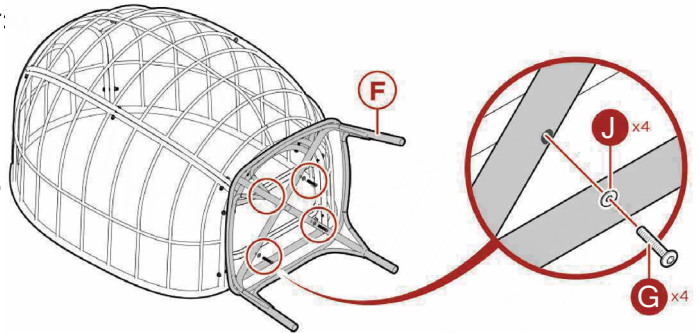

### STEP 5

Carefully, and with help, stand your egg chair on its feet and check stability. Add cushions [N, O and 2x P]. Your egg chair is now complete!

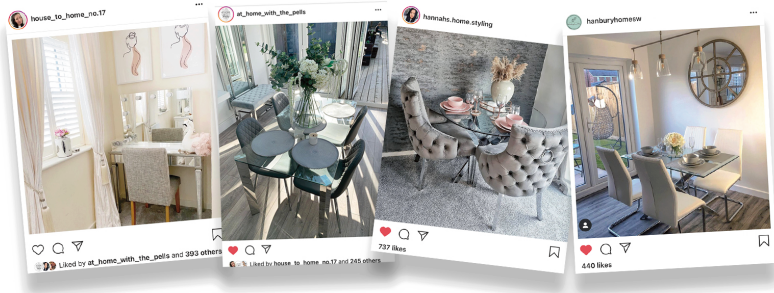

## WE **LOVE** INTERIORS! SHARE YOURS WITH US ON SOCIAL MEDIA

1. follow us on Instagram
2. post your interior
3. tag us to be featured



@furnitureboxUK



@furniturebox\_uk



@furnitureboxuk

# LOOKING GOOD!

Now you've assembled your garden furniture find out how to care for your item and keep it looking brand new.



Look for your care guide in the box or visit:  
[www.furniturebox.co.uk/club/care-guide](http://www.furniturebox.co.uk/club/care-guide)

[www.furniturebox.co.uk](http://www.furniturebox.co.uk)



## OUR 1 YEAR GUARANTEE

our products come with a 1 year guarantee to give you peace of mind shopping at Furniturebox



## WHAT THE GUARANTEE COVERS



**PRE-INSERTED FIXINGS**  
e.g. lose metal threads



**FAULTY JOINTS**  
e.g. legs bending



**EXTERNAL FIXING FAULTS**  
e.g. metal discs removing from table top



**STRUCTURAL INTEGRITY**  
e.g. the frame of the product



### ACTIVATE YOUR GUARANTEE ONLINE

scan this QR code with your phone to read the full guarantee online and register your product. It only takes a moment to fill out. Or visit: [furniturebox.co.uk/our-guarantee](https://furniturebox.co.uk/our-guarantee)

Furniturebox UK, Beaumont Business Centre,  
Woodlands Road, Mere, Wiltshire, BA12 6BT  
Tel: 01747 863333 Email: [sales@furniturebox.co.uk](mailto:sales@furniturebox.co.uk)