

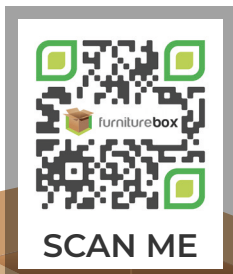

BELGRAVIA CHAIR

ASSEMBLY GUIDE

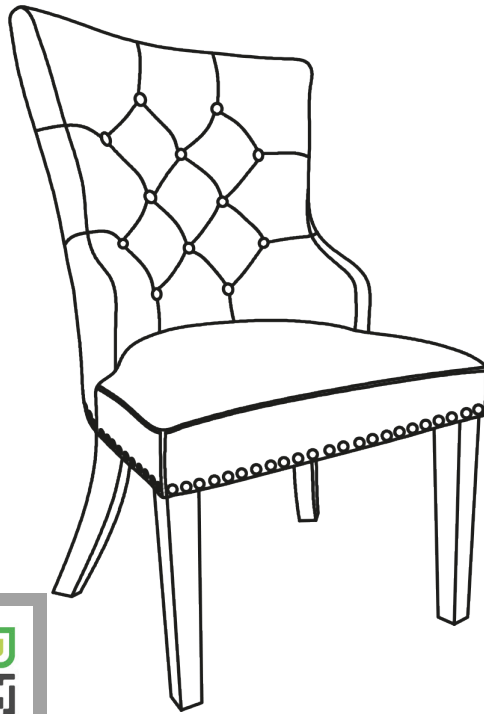

www.furniturebox.co.uk

Scan QR code for more tips,
advice and assembly video or visit
furniturebox.co.uk/club/belgravia-chair

Important - Please read these instructions fully before starting assembly



**SAFETY AND
CARE ADVICE**



NO POWER TOOLS

SAFETY AND CARE ADVICE

- Check you have all the components and tools listed.
- Remove all fittings from the plastic bags and separate them into their groups.
- We do not recommend the use of power drills/drivers for inserting screws, as this could damage the unit. Only use hand screwdrivers and Allen keys.
- Keep children and animals away from the work area, small parts could cause choking if swallowed.
- Make sure you have enough space to layout the parts before starting.
- Assemble the item as close to its final position (in the same room) as possible.
- Do not overtighten the nuts to avoid causing damage to the threads.
- Only clean using a damp cloth and mild detergent, do not use bleach or abrasive cleaners.
- From time to time check that there are no loose screws on this unit
- This product should not be discarded with household waste. Take to your local authority waste disposal centre



Follow us on Instagram
@furniturebox_uk

IMPORTANT INFORMATION



30 MINUTE
BUILD









ONE
PERSON



MAXIMUM
CAPACITY 130Kg

PLEASE CHECK CAREFULLY AND MAKE SURE YOU HAVE ALL FITTINGS AND TOOLS LISTED BELOW BEFORE YOU START.

No.	Description	Sketch	Qty'
A	Back and Seat Cushion		1 pc
B	Front Leg		2 pcs
C	Back Leg		2 pcs

No.	Description	Sketch	Size	Q'ty
1	Bolt		5/16*2-1/4"	8pcs
2	Lock Washer		5/16*13mm	8pcs
3	Flat Washer		5/16*19mm	8pcs
4	Allen Key		5/16"	1pc

NOTE: The quantities above are the correct amount to complete the assembly. In some cases more fittings may be supplied than are required.

STEP 1

Place the back and seat cushion part [A] upside down over the edge of a stable table to work on.

Attach the Front Leg [B] to the front corner of the Seat Cushion Frame [A] by using Lock Washer [2] followed by Flat Washer [3] and then slotting Bolt [1] through washers and hole. Secure with Allen Key [4].

Attach the Back Legs [C] to the back corner block of Seat Cushion Frame [A] by using Lock Washer [2] followed by Flat Washer [3] and then slotting Bolt [1] through washers and hole. Secure with Allen Key [4]. Do not fully tighten all bolts

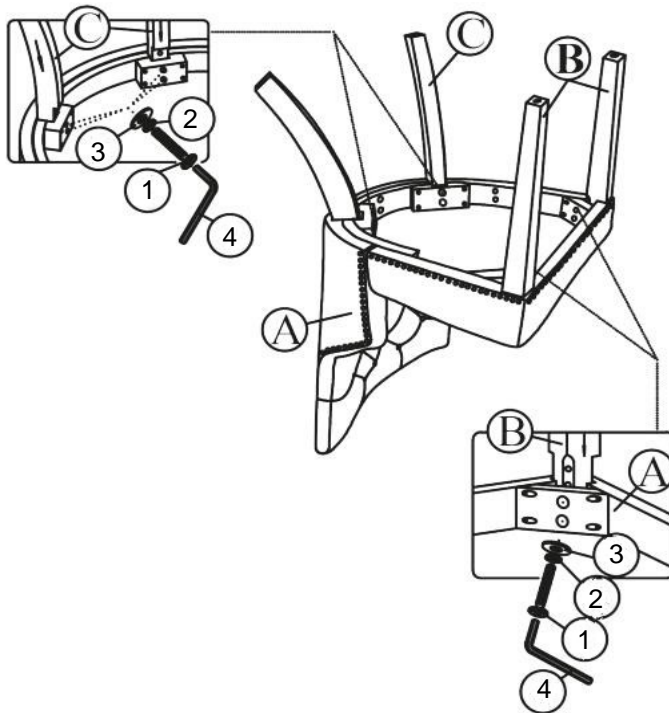

STEP 2

Turn the chair to upright position and place it on flat surface. Adjust legs so that Chair is level and does not wobble. Fully tighten all Bolts at this time with Allen Key [4]. Do not over tighten. Your chair is now ready to use.

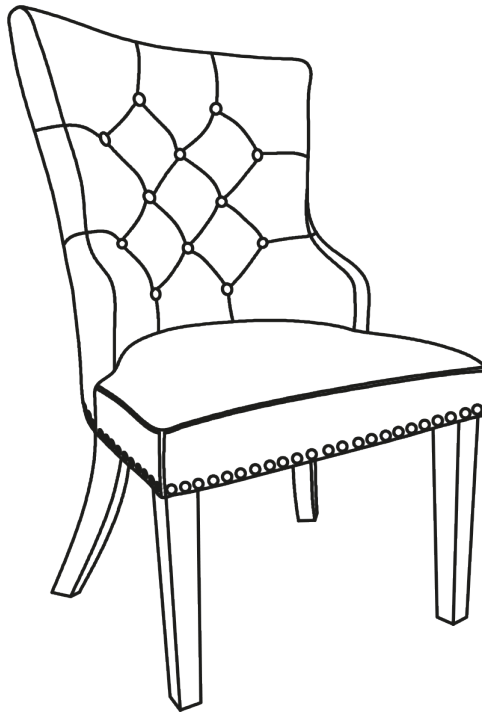

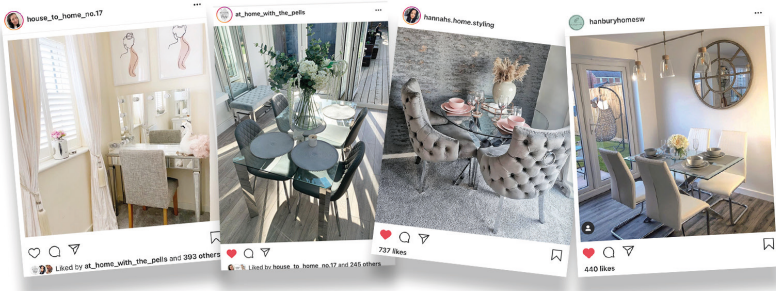

WE **L**OVE INTERIORS! SHARE YOURS WITH US ON SOCIAL MEDIA

1. follow us on Instagram
2. post your interior
3. tag us to be featured



@furnitureboxUK



@furniturebox_uk



@furnitureboxuk

LOOKING GOOD!

Now you've assembled your product find out how to care for your item and keep it looking brand new.

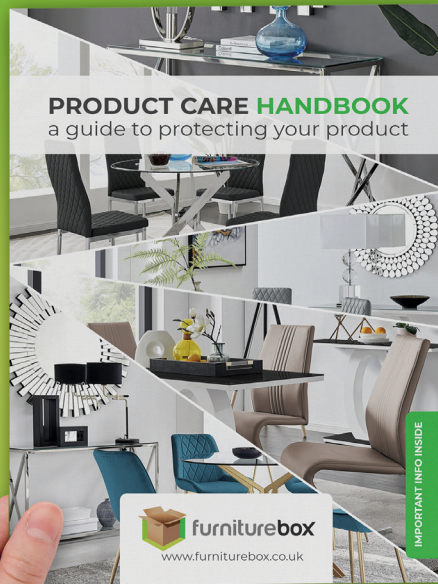

Look for your care guide in the box or visit:
www.furniturebox.co.uk/club/care-guide

www.furniturebox.co.uk



OUR 1 YEAR GUARANTEE

our products come with a 1 year guarantee to give you peace of mind shopping at Furniturebox



WHAT THE GUARANTEE COVERS



PRE-INSERTED FIXINGS
e.g. lose metal threads



FAULTY JOINTS
e.g. legs bending



EXTERNAL FIXING FAULTS
e.g. metal discs removing from table top



STRUCTURAL INTEGRITY
e.g. the frame of the product



ACTIVATE YOUR GUARANTEE ONLINE

scan this QR code with your phone to read the full guarantee online and register your product. It only takes a moment to fill out. Or visit: furniturebox.co.uk/our-guarantee



Furniturebox UK, Beaumont Business Centre,
Woodlands Road, Mere, Wiltshire, BA12 6BT
Tel: 01747 863333 Email: sales@furniturebox.co.uk